

The obsta spherical markers are compliant with International Civil Aviation Organisation (ICAO) annex 14 chapter 6 recommendations. They are used for day marker for meteorological towers (guyed structures), ground cable on transmission lines etc

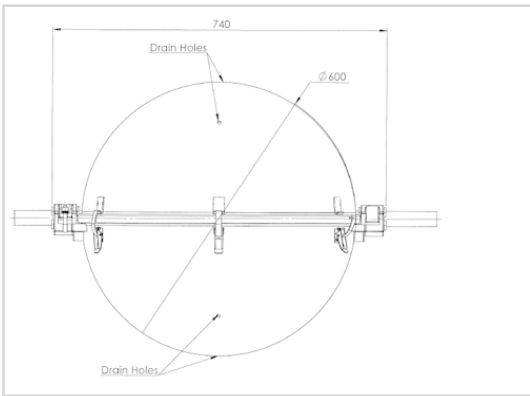

- overall diameter 600mm
- material: aluminium
- Designed for high voltage cable up to 400KV
- No losing parts and easy installation with only 2 screws and draw latches



Mechanical Characteristics

Cable diameter	ø51,7-52,0mm
Color	red