

# Installation notice

## WIRING DIAGRAM

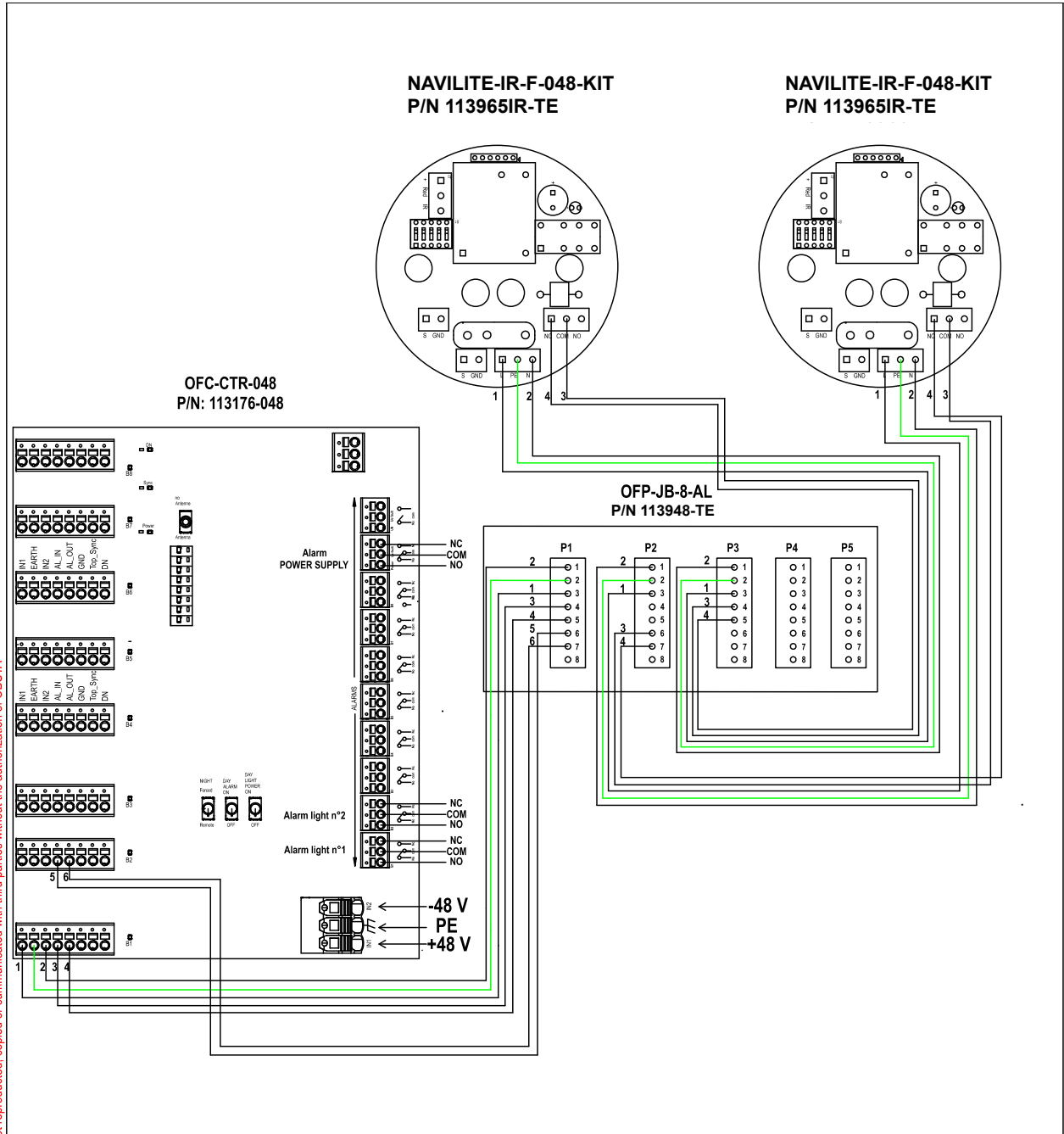





Ce document est la propriété d'OBSTA. Il ne peut être reproduit ou communiqué à des tiers sans son autorisation. This drawing / covers are the property of OBSTA. This document cannot be reproduced, copied or communicated with third parties without the authorization of OBSTA.

<b>B</b>	17/06/2024	Modification de la légende de câblage	
<b>IND/REV</b>	<b>DATE</b>	<b>NATURE DE LA MODIFICATION / MODIFICATION</b>	
Reims Factory		<b>Typical lighting System Installation</b>	
3, Impasse de la Blanchisserie BP 56 51052 REIMS CEDEX (France) Tel. 03.26.85.74.00		<b>CODE:</b>	<b>PLAN:</b> <b>DRAWING:</b> O-CUS-597-NAV
<b>ECHELLE:</b> <b>SCALE:</b>		<b>MATIERE:</b> <b>MATERIAL:</b>	ANNULE ET REMPLACÉ CANCELED AND REPLACED
<b>REPÈRE DESSIN</b> REFERENCE DRAWING:	<b>DESSIN PAR:</b> DESIGNED BY:	<b>DATE:</b>	<b>APPROUVE PAR:</b> APPROVED BY:
.DWG	B.SIOZAC	27/05/2024	H.BURGAUD
			<b>DATE:</b> 27/05/2024
			<b>VISA:</b>

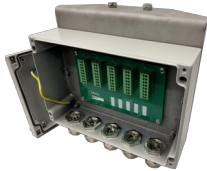
# Installation notice

## 1 Content of the kit

 <p>113965IR-KIT-TE x 2</p>	 <p>113948-TE x 1</p>	 <p>113789-NAV-114 x 3</p>	 <p>113789-OXA4-1X17 (1 for 60cm of 127113)</p>	 <p>113176-048 x 1</p>	 <p>127113</p>
--	--	---	--	--	---

## 2 Installation

1. On the ground, connect the 2 navilite to the junction box according to the wiring diagram. Ensure that the shield of the cable is in contact with the claws in the cable glands.

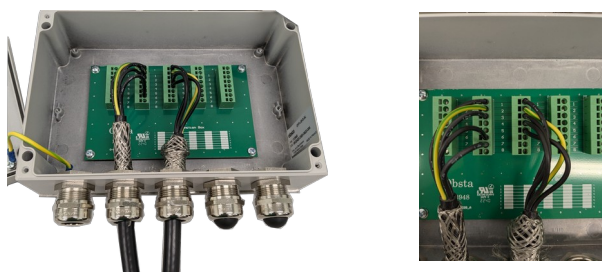



2. Bring the 2 lights and the junction box at the top of the pylon and fix them using the U-bolts and the screws + washers supplied in the kit.



3. Connect the 7G1.5mm<sup>2</sup> cable to junction box according to the wiring diagram and close the junction box. Attach the cable along the pylon using the cable clamp from the kit.



4. In the shelter, connect the 7G1.5mm<sup>2</sup> cable to the controller 113176-048. Use the cable through the M25 cable gland in the controller and set the switches.

	<p>Configured the switches S1, S2, S3 : :</p> <ol style="list-style-type: none"> <li>1. S1 : Remote</li> <li>2. S2 : DAY ALARM ON</li> <li>3. S3 : DAY LIGHT POWER ON</li> </ol>	
---	--	---