

View of the complete system:

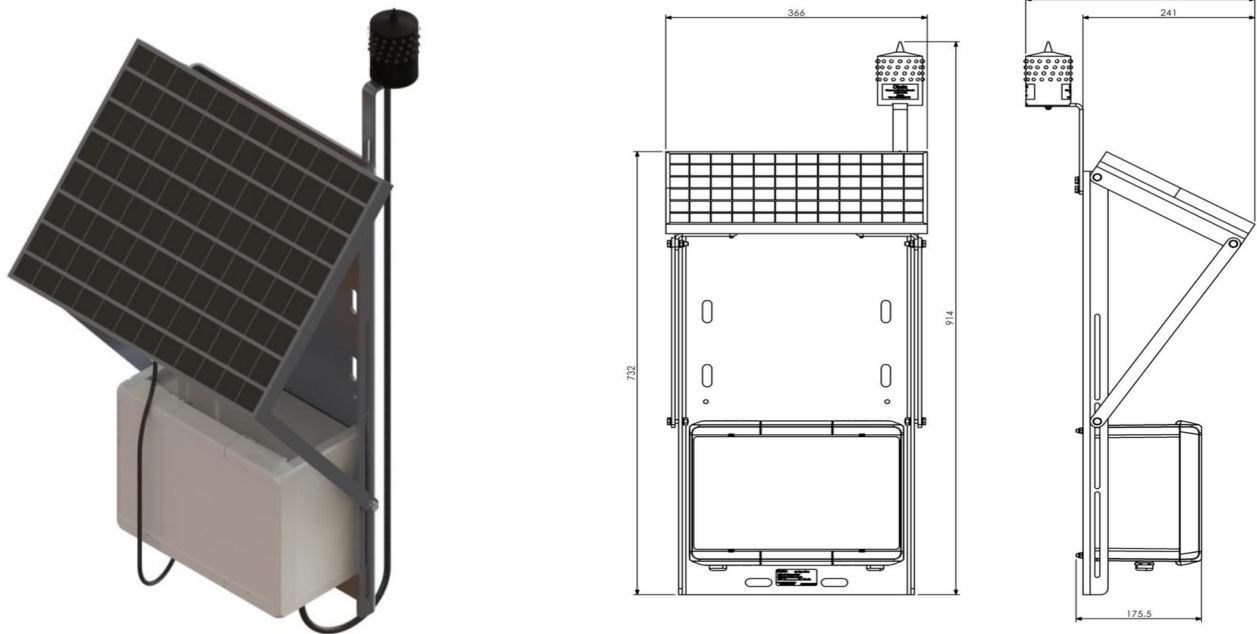

1. Mechanical installation: Set the complete solar kit as per the view below

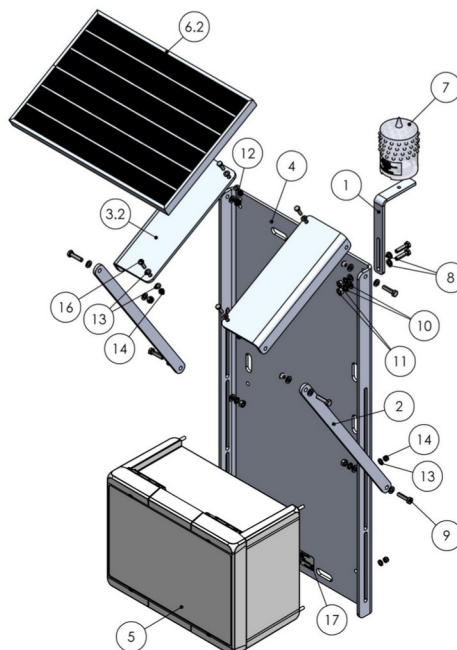

The solar kit is already pre-assembled

In Oman, adjust the tilt of the solar panel to approximate 15° above horizontal

2. Electrical wiring



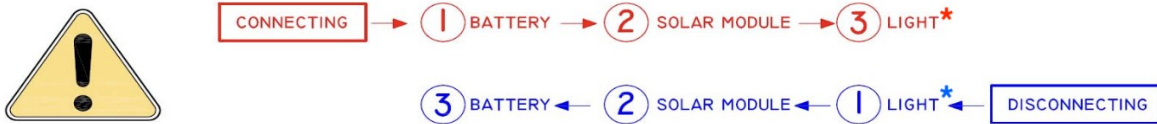

Warning: it is very important always to connect first the battery to the regulator and secondly the solar panel to the regulator. If the solar panel is connected first to the regulator without the battery, the regulator may be destroyed and warranty will not apply

CONNECT THE CABLE ON THE REGULATOR IN THE FOLLOWING ORDER TO AVOID MALFUNCTION

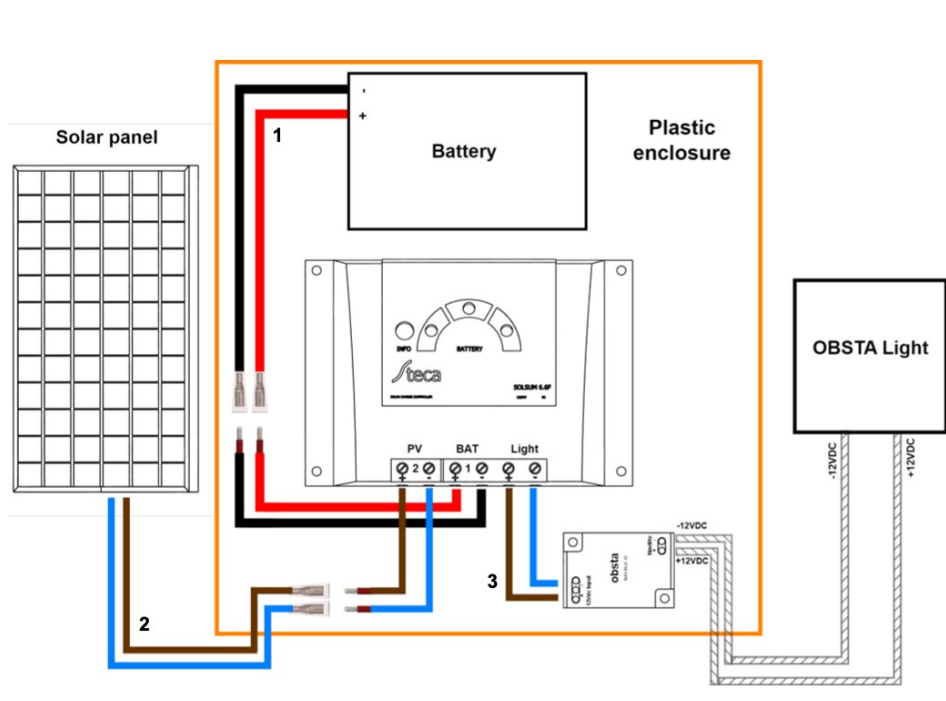

* : OBSTA light should be first connected to the OBSTA blinker and then to the regulator



- 1  : Cable from battery to regulator
- 2  : Cable from solar panel to regulator
- 3  : Cable from OBSTA light to OBSTA blinker
-  : Cable from OBSTA light + blinker to regulator

3. Test

Once the system is wired, cover completely the solar panel and wait a few minutes until the NAVILITE starts blinking red