

The obsta spherical markers are compliant with International Civil Aviation Organisation (ICAO) annex 14 chapter 6 recommendations.

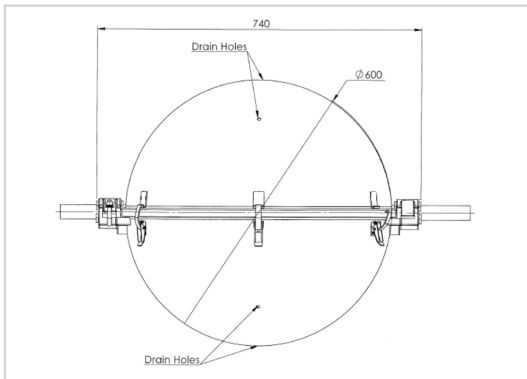

- ✦ overall diameter 600mm
- ✦ material: aluminium
- ✦ Designed for high voltage cable up to 400KV
- ✦ No losing parts and easy installation with only 2 screws and draw latches



Mechanical Characteristics	
Cable diameter	ϕ 17,6-19,5mm
Color	orange