

The obsta spherical markers are compliant with International Civil Aviation Organisation (ICAO) annex 14 chapter 6 recommendations. They are used for day marker for meteorological towers (guyed structures), ground cable on transmission lines etc

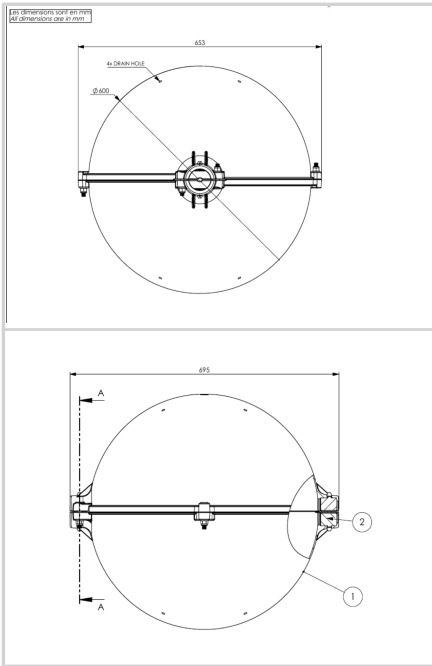

- overall diameter 600mm
- material: polyethylene
- clamps suitable for ground cable or OPGW
- color: white, red or aviation orange as per ICAO (annex 14 chapter 6 of International Civil Aviation Organisation)
- designed for ground cable, OPGW cable, guy wires etc
- easy and quick assembly with 6 nuts only to clamp it to the cable
- 8 drain holes per sphere



Mechanical Characteristics	
Cable diameter	Ø12,5-18,5mm
Color	orange
Weight	4kg
Standards	
Standards compliance	ICAO annexe 14 chapter 6 (8th edition 07/2018), EASA (4th edition 2017)