

The obsta spherical markers are compliant with International Civil Aviation Organisation (ICAO) annex 14 chapter 6 recommendations. They are used for day marker for meteorological towers (guyed structures), ground cable on transmission lines etc

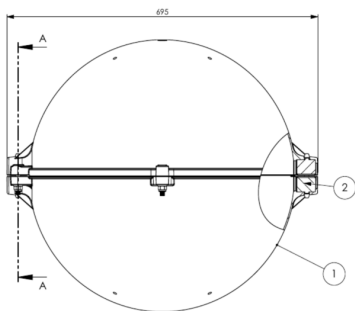

- ✦ overall diameter 600mm
- ✦ material: polyethylene
- ✦ clamps suitable for ground cable or OPGW
- ✦ color: white, red or aviation orange as per ICAO (annex 14 chapter 6 of International Civil Aviation Organisation)
- ✦ designed for ground cable, OPGW cable, guy wires etc
- ✦ easy and quick assembly with 6 nuts only to clamp it to the cable
- ✦ 8 drain holes per sphere

ES: dimensiones son en mm
EN: dimensions are in mm

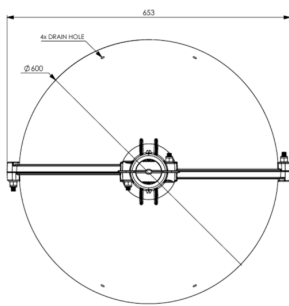

Mechanical Characteristics

Cable diameter	Ø12,5-18,5mm
Operating temperature	-50/+80°C
Color	red
Weight	4kg

Standards

Standards compliance	ICAO annexe 14 chapter 6 (8th edition 07/2018), EASA (4th edition 2017)
----------------------	---